

SHOR-LINE[®]

SINCE 1927

Quality Equipment...

An Investment for Life!

Equipment Catalogue

April 2019

www.shor-line.co.uk

info@shor-line.co.uk

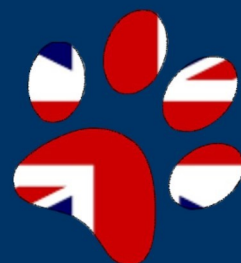



Quality Equipment...

An Investment for Life!

Welcome to the new Shor-Line Product Catalogue April 2019.

For over 90 years, Shor-Line has maintained the quality of our products and customer service in its business philosophy.

As innovators to the Veterinary industry, Shor-Line is constantly refining and adding to an extensive array of products to help you, the Veterinary professional in your vital role in providing the best possible care for your patients.

So, please enjoy our new catalogue of products and we look forward to working with you.

Your sincerely,

*The **SHOR-LINE** team.*

KENNELS - LIFETIME GUARANTEE

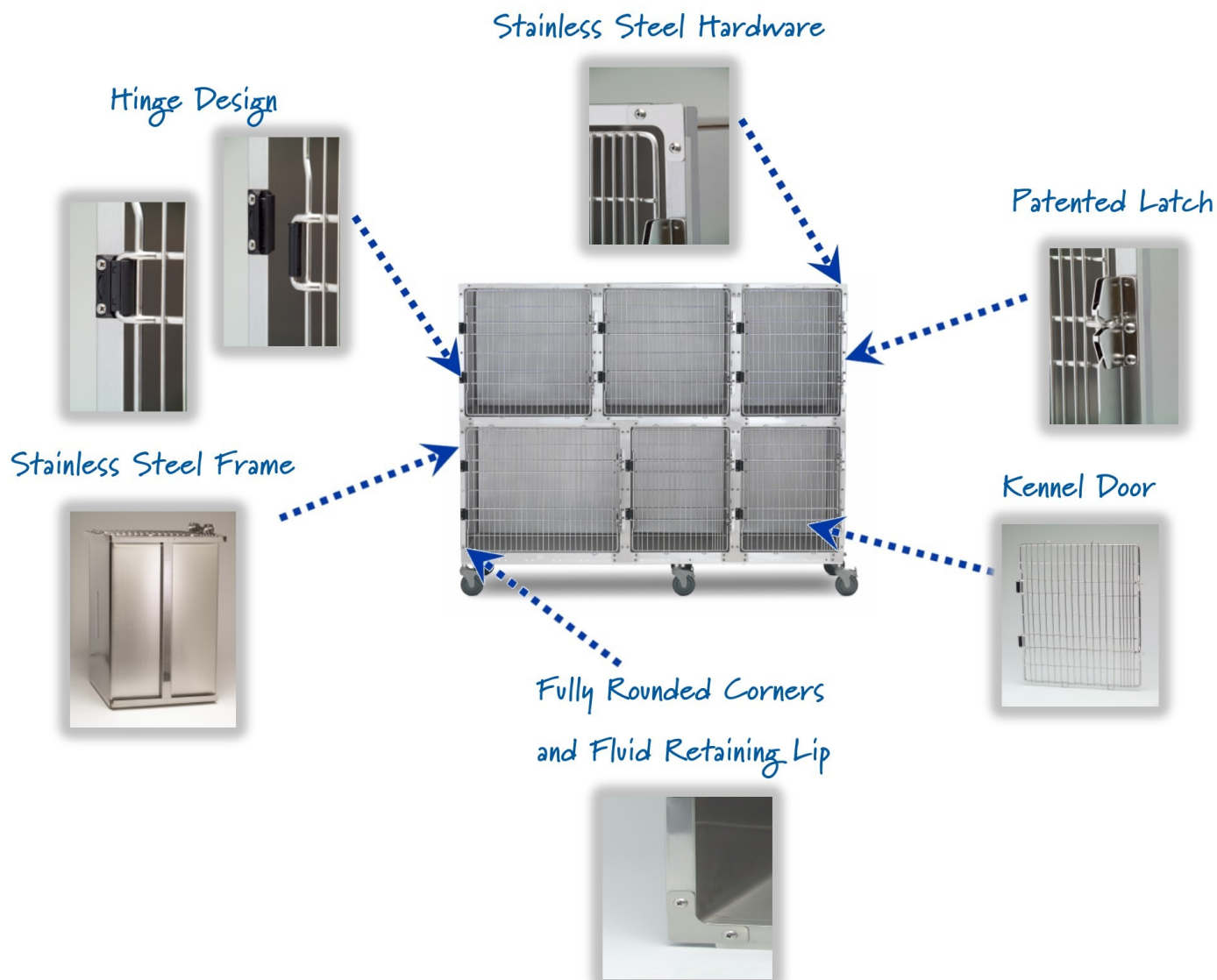

Hardware

All Trim Plates and Trim Strips are made from stainless steel with rounded corners. No sharp edges or points.

Patented Latch

The latch is designed to be durable, secure and quiet. Acetal bushings provide smooth operation and sound dampening qualities. The concave latch bar design enables the kennel door to be opened with the forearm when handling sedated or awkward animals.

Kennel Door

The one piece frame and wrap around hinge/latch bars are formed from 9.5mm diameter solid stainless steel rods. All additional horizontal rods are 6mm in diameter and all vertical rods are 4.8mm in

diameter. Every intersection of horizontal and vertical rods are welded, providing incredible strength.

Fully Rounded Corners and Fluid Retaining Lip

No 90° corners to trap germs and debris. A smooth rounded cove in the back and all internal sides of the kennel. A slightly raised, fluid retaining lip prevents spillage out of the front of the kennel.

Stainless Steel Frame

All frame members are made from heavy duty stainless steel to provide you many years of solid structural support from your kennel assemblies.

Hinge Design

Our new hinge has been designed and

developed for strength and utility. The hinge is constructed of 14 gauge stainless steel that is encapsulated by an injection moulded, fibreglass reinforced thermoplastic polymer.

The snap together bushing on the door frame is also moulded from thermoplastic polymer with permanent, self lubricating properties resulting in a silky smooth and silent swing.

The new hinge design also allows for the quick and easy removal of the door for cleaning and reattachment without tools.

Our doors, latches and hinges are completely reversible which allows you to change your kennel from a right latch to a left hand latch, or vice versa at any time.

KENNELS

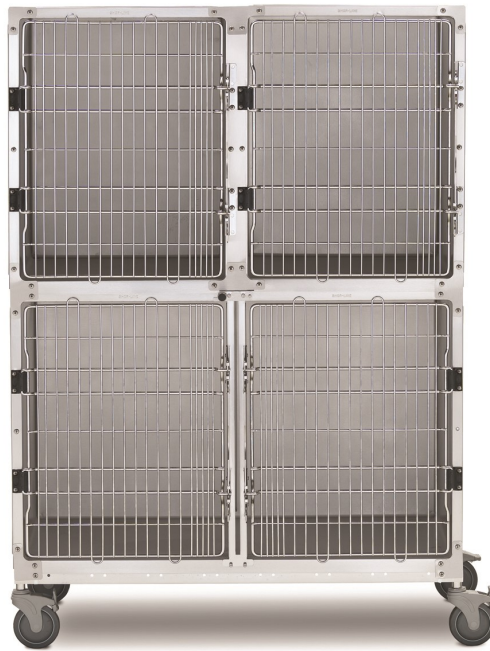

What's in a Kennel?

Materials

Our kennels are constructed from the highest grades of austenitic stainless steel material. Even the square tube frame, kennel shell, trim hardware, screws and platforms are made of heavy gauge stainless steel.

Fabrication

Shor-Line Kennels are fabricated from our exclusive 2-piece unitised construction process, minimizing the number of welded seams. Less welds mean stronger and longer lasting kennels.

Modular Assemblies

Our kennels are completely modular. This means each kennel is manufactured as an individual unit, engineered for fit and function to combine with others into one structural product. When you put them together, they look custom built, specially for your housing area. Installation is quick and easy. Our kennels are configured in 152.4mm increments (457.2mm, 609.6mm, 762mm, 914.4mm, etc.). When planning space requirements, allow an additional 3mm in width for every two kennels that are side-by-side.

A Polished Look









All stainless steel hardware (trim strips, trim plates and screws) tie each assembly together for a finished look. The kennels themselves have a front flange which overlaps the lower kennel or base platform, covering all horizontal joints.

Standing Tall

A platform to support the kennel assembly may be ordered from Shor-Line with your kennel purchase.

Standard Industry Kennel Sizes

Kennels are 717.7mm deep not including latch.

Product Code	Width (mm)	Height (mm)	Size of Kennel suits
902.1818.70	457.2	457.2	
902.1824.70	457.2	609.6	
902.2418.70	609.6	457.2	
902.2424.70	609.6	609.6	
902.2430.70	609.6	762	
902.3024.70	762	609.6	
902.3030.70	762	762	
902.3036.70	762	914.4	
902.3624.70	914.4	609.6	
902.3630.70	914.4	762	
902.3636.70	914.4	914.4	
902.4230.70	1066.8	762	
902.4236.70	1066.8	914.4	
902.4830.70	1219.2	762	
902.4830.73 (Double Door)	1219.2	762	
902.4836.70	1219.2	914.4	
902.4836.73 (Double Door)	1219.2	914.4	
902.6036.73 (Double Door)	1524	914.4	
902.7236.73 (Double Door)	1828.8	914.4	

SHOR-LINE KENNEL RUN GATES

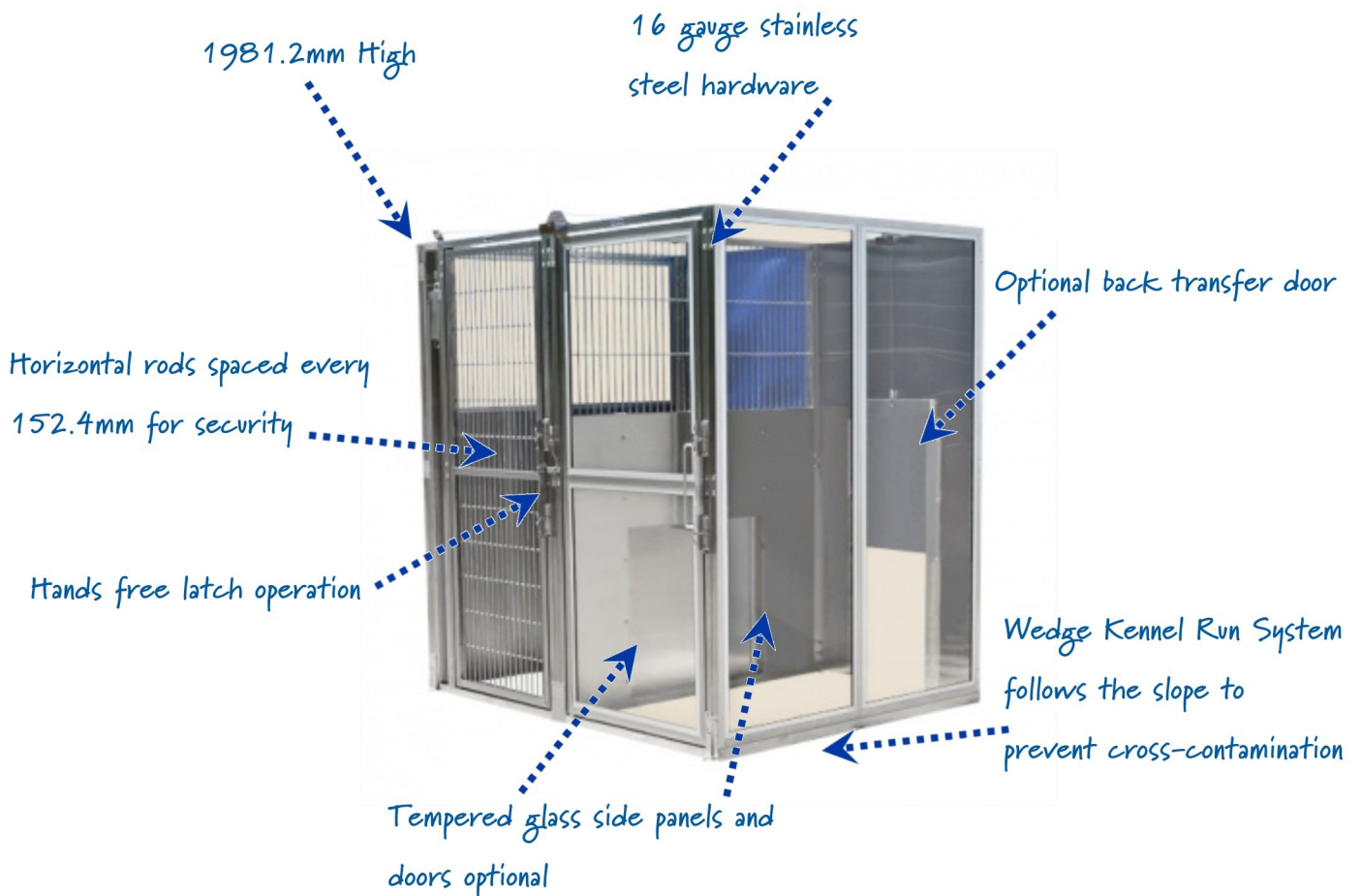

Frames

All frames are constructed of 31.75mm square stainless steel tubing. All corners are mitered and hand welded.

Patented Latch

Our latch is designed to be durable, secure and quiet. Acetal bushings provide smooth operation and sound dampening qualities. Concave latch bar allows the Run Gate to be opened with your forearm if both your hands are occupied.

Horizontal and Vertical Rods

All rods are 6.35mm diameter solid stainless steel and welded at every intersection. Horizontal rods are spaced 152.4mm apart and vertical rods are 38.1mm apart. The result is a safe and rugged gate.

PVC Floors

Keep patients and boarding clients clean, dry and comfortable. Supplied in sections for easy removal and cleaning, they are supported by stainless steel stirrups (Raised Floor Run System Only).

Adjustable Legs

Front leg has adjustable levelling pad and rear leg has a 101.6mm telescopic adjustment to assure a level and square installation (Raised Floor Run System Only).

Horizontal Brace

The horizontal brace provides additional strength and is the same 31.75mm stainless steel tubing as the frame. All vertical rods are inserted into the frame and through the brace.

Isolation Panel

Available in standard 1219.2mm high or "total isolation". Constructed of two stainless steel sheets, one exterior and one interior, welded to the frame. Sound dampening material sandwiched between these two sheets prevents an "oil canning" affect.

Assembly Hardware

All assembly hardware, screws and barrel nuts are stainless steel.

Gates

Gates are available as all Grill Stainless Steel, half Glass half Grill, or all Glass Panels.

SHOR-LINE KENNEL RUN GATES

FLOOR

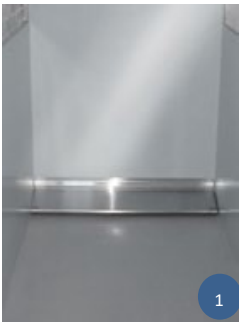

1



2



3

1 Concrete Floor with Trench Drain Cover

Your facility is built with a trench drain system and the kennel walls sit on concrete. We offer half and full trench drain covers (half is shown). An alternative is to cover the Trench Drains with a Flip Up Resting Bench.

2 Sloped Floor with Concrete Trench Drain

The built-in side panel and wedge system has an adjustable wedge that conforms to the concrete slope. Once sealed, it creates a barrier against cross contamination. It works with your existing trench drain system.

3 Elevated PVC-Coated Floor

We take a 14-gauge, round-holed, heavy-duty steel sheet and coat it with 3mm thick layer of PVC coating.

GATE & BACK PANEL SIZE

- 762mm Wide
- 914.4mm Wide
- 1219.2mm Wide

SIDE PANEL SIZE

- 1524mm Long
- 1828.8mm Long

GATES



1



2



3

1 Full Stainless Steel Frame

Gate frame and gate panel are constructed of welded 31.75mm square stainless steel tubing and stainless steel wire mesh.

2 Stainless Steel Frame & Glass Door Gate

Gate frame and door are constructed of welded 31.75mm square stainless steel tubing. Tempered glass is encased by an aluminium extrusion mounted to the gate and door frame.

3 Stainless Steel without Bottom Bar

Door is constructed of welded 31.75mm square stainless steel tubing with reinforced frame and stainless steel wire mesh.

SHOR-LINE KENNEL RUN GATES

SIDE PANELS



1 Full Isolation

Strong stainless steel panels add brightness and make cleaning easy. Two heavy -gauge stainless steel panels are sandwiched between a Sound Dampening Technology core to help reduce sound and add strength. Also available in tempered glass or PVC. Full isolation covers the entire 1981.2mm.



2 1219.2mm Isolation

Choose from heavy-duty stainless wire mesh or tempered glass for the 762mm top section and your choice of stainless steel, or PVC for the bottom 1219.2mm section. Uses the same Sound Deadening Technology as Full Isolation.



3 Full Height or 48" Cement Masonry Unit

Benefits are no cross contamination possibilities and total isolation. You can place our 762mm stainless steel or tempered glass Flag Panels on top.

BACK PANELS



1 Full isolation

Stainless steel panels add brightness and make cleaning easy. Full isolation covers 1981.2mm.



2 1219.2mm Isolation

Heavy duty stainless steel mesh covers the 762mm top section. Choose stainless steel or PVC panels for the bottom 1219.2mm.



3 No Back Panel

In many spaces, you can use your existing wall as the kennel back panel.

T-KENNEL RUN SYSTEM



Frames

All frames are constructed of 25.4mm square stainless steel tubing. All corners are mitered and hand welded.

Doors

Choose from tempered glass or wire doors. Doors can open in or out and are completely removable to aid cleaning.

Horizontal and Vertical Rods

All rods are 4.57mm diameter solid stainless steel and welded at every intersection. Horizontal rods are spaced 152.4mm apart and vertical rods are 38.1mm apart. The result is a safe and rugged gate.

PVC Side and Back Panels

Two strong 2.3mm PVC Panels are sandwiched between a Sound Dampening Technology core to help reduce sound and add strength. Side panels available in 1219.2mm semi-isolation or 1828.8mm high full isolation.

Adjustable drop bar

The adjustable drop bar follows the slope of the floor to prevent cross-contamination.

Optional Feeding System

Food and water optional feeding systems

are available (must be ordered at time of manufacture).

Assembly Hardware

All assembly hardware, screws and barrel nuts are stainless steel.

Gates

Gates are available as all Grill Stainless Steel, half Glass half Grill, or all Glass Panels.

Applications

Outdoor applications are available.

T-KENNEL RUN SYSTEM

FLOOR



1



2

1 On Concrete Floor with Trench Drain Cover

Economical alternative to Stainless Steel but it may require maintenance over time.

2 Raised Floor

The raised floor allows you to disassemble and move the runs, if needed. It also allows you the option to connect to a drain (trench drain covers optional). The flooring is 4mm PVC in a variety of colours.

FRAME



1

1 Stainless Steel

Best looking frame. Holds up well to liquids and cleaning products and is virtually maintenance free.

GATE & BACK PANEL SIZE

- 914.4mm Wide
- 1066.8mm Wide
- 1219.2mm Wide

SIDE PANEL SIZE

- 1219.2mm Long
- 1524mm Long
- 1828.8mm Long
- 2438.4mm Long

GATE STYLE



1



2

1 Stainless Steel

Solid stainless steel frame provides maximum durability and clean look.

2 Tempered Glass

The frame is stainless steel. Tempered glass is encased in an aluminium extrusion, and we mount that to the gate frame.

3 Half PVC

The top 609.6mm can either be wire mesh or tempered glass. The lower 1219.2mm can be coloured PVC.



3

T-KENNEL RUN SYSTEM

SIDE PANELS

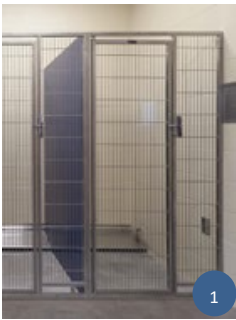

1 Full Isolation

Two strong 2.3mm PVC panels are sandwiched between a Sound Dampening Technology core to help reduce sound and add strength. The panels add colour and make cleaning easy. Full isolation 1828.8mm.



2 1219.2mm Isolation

Choose between stainless steel or tempered glass for 609.6mm top section. Strong 2.3mm PVC panels (bottom 1219.2mm) clean easily and add colour. Uses the same Sound Dampening Technology as Full Isolation.



3 Full Height or 1219.2mm Cement Masonry Unit

Benefits are no cross contamination possibilities and total isolation. You can place our 609.6mm stainless steel wire mesh, tempered glass or PVC panels on top.

BACK PANELS



1 Full Isolation

Strong 2.3mm PVC panel add colour and make cleaning easy. Full isolation 1828.8mm.

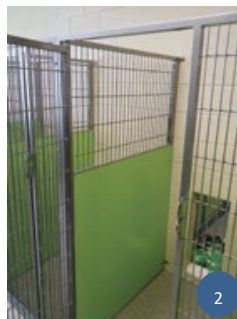

2 No Back Panel

In many spaces, you can use your existing wall as the kennel back panel. (This includes CMU walls).

PVC PANEL COLOURS

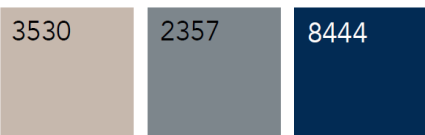

Other colours available on request

STAINLESS STEEL DOUBLE CAT SUITE



The Mobile Free Standing Stainless Steel Double Cat Suite provides a large amount of living space whilst offering a nurturing environment.

The Stainless Steel construction provides the best surface for disinfection and long service life.

All features have been designed to relieve the stress of your patient which leads to a safer environment for both feline and handler.

- Lockable door latch to prevent escapes
- Stainless steel door design discourages paw entrapment
- Silent latch mechanism eliminates noise and creates a stress-free environment for patients
- Integrated compartment divider can be removed for cleaning
- Portals can be opened and closed from the outside without opening kennel doors or disturbing patients
- Interior polymer components are made of chemical resistant Polyethylene (PE)
- End and Top Panels together with Stainless Steel Quiet Time Door Cover included

Mobile Free Standing Stainless Steel Double Cat Suite

Product Code	Description
902.0103.24	Mobile Free Standing Stainless Steel Double Cat Suite
902.4830.20	Kennel: Width 1219.2mm x Height 762 mm x Depth 717.6mm with Cat Suite

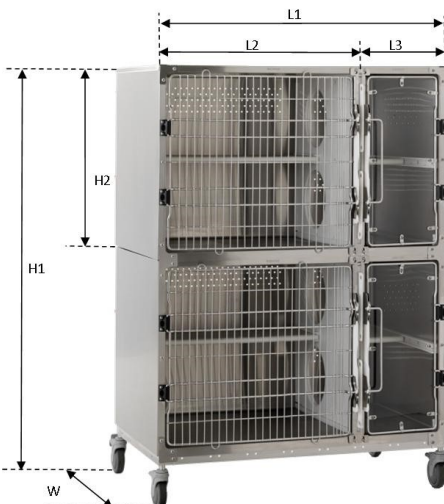

Mobile Free Standing Stainless Steel Double Cat Suite Sizes

W (mm)	H1 (mm)	H2 (mm)	L1 (mm)	L2 (mm)	L3 (mm)
717.7	1739.9	762	1219.2	914.4	304.8

CAT CONDO



All condos inside depth are 679.5mm deep not including latch. All condos outside depth are 698.5mm deep not including latch.

Through continued discussions with customers and industry leaders, we have gathered information of how cats behave when they are away from home in a veterinary environment. This has resulted in the Cat Condo that is aesthetically pleasing as well as soft on their paws.

Two door options are available: The **clear, Polycarbonate door** covers the entrance while providing horizontal ventilation slits —a shape that makes cleaning easier. Provides a clear view of the patient.

The **Full Grill Door** allows good airflow through the door and extra rods at the latch to protect paws.

Cat Condo features:

- **Fine-celled foam board material** - strong and impervious to moisture
- **2 door choices** - Polycarbonate or Stainless Steel Grill Door
- **Quiet-Closing Latches** - lowers feline stress
- **Durable Hinges** - made from injection moulded, fibreglass-reinforced thermoplastic polymer
- **Optional storage** - Door or drawer

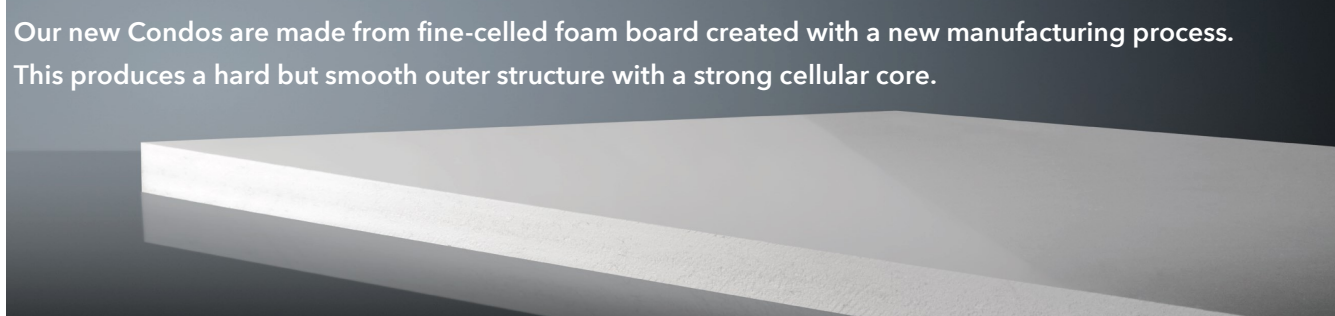

Our new Condos are made from fine-celled foam board created with a new manufacturing process. This produces a hard but smooth outer structure with a strong cellular core.

CONDO SIZES

	Small (Width x Height x Depth)	Medium (Width x Height x Depth)	Large (Width x Height x Depth)
Outside dimension:	609.6mm x 762mm x 698.5mm	762mm x 762mm x 698.5mm	1066.8mm x 762mm x 698.5mm
Inside dimension:	572mm x 724mm x 679.5mm	724mm x 724mm x 679.5mm	1028.8mm x 724mm x 679.5mm
or			
Outside dimension:	609.6mm x 609.6mm x 698.5	762mm x 609.6mm x 698.5mm	1066.8mm x 609.6mm x 698.5mm
Inside dimension:	572mm x 572mm x 698.5	724mm x 572mm x 698.5mm	1028.8mm x 572mm x 698.5mm



PLASTIC KENNELS

Precision engineered to meet your requests for an alternative approach to animal kennels, these kennels are ideal for animal holding after bathing or grooming, or to add to your existing holding cage system.

The kennels are available in two sizes, medium and large (please see below for details). Also available are two styles of kennel; standard and a standard kennel with raised floor and removable collection pan (Quick Clean). The "Quick Clean" kennel features a removable collection pan thermoformed from high impact black polystyrene. This moulding process eliminates leaky seams and ensures years of use. A black powder coated divider is included for the large kennel to separate into two smaller kennels.



Plastic Kennels

Product Code Description

Plastic Kennel Assemblies

925.3000.02	3 Unit Plastic-Kennel Assembly (Includes Divider and Mobile Platform)
925.4000.02	4 Unit Plastic-Kennel Assembly (Includes Mobile Platform)
925.6000.02	6 Unit Plastic-Kennel Assembly (Includes Mobile Platform)

Quick Clean Plastic Kennel Banks with Floor and Pan.

925.3000.12	3 Unit "Quick Clean Plastic Kennel" Assembly with Floor, Pan, Divider and Mobile Platform
925.4000.12	4 Unit "Quick Clean Plastic Kennel" Assembly with Floor, Pan and Mobile Platform
925.6000.12	6 Unit "Quick Clean Plastic Kennel" Assembly with Floor, Pan and Mobile Platform

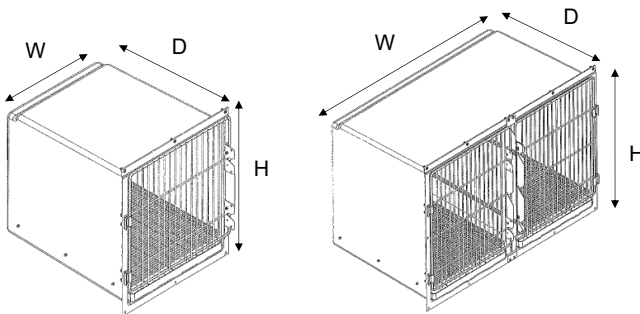

Plastic Kennels Sizes

Product	W (mm)	H (mm)	D (mm)
Medium Plastic Kennel	615.9	712.0	720.7
Large Plastic Kennel	1231.9	876.3	720.7

ISOLATION KENNELS

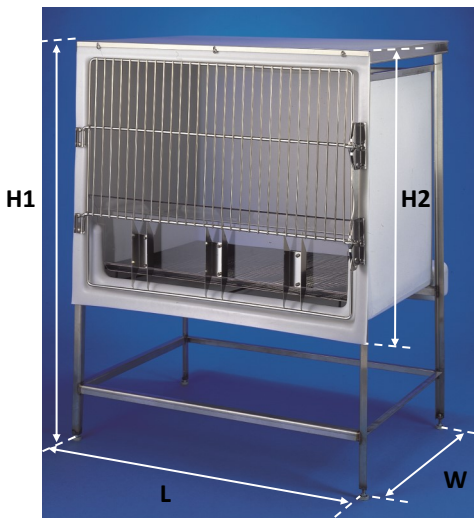

When there is the need to isolate potentially infectious clients, you can do so using the Parvo Kennel. Clean up is fast and easy due to the raised floor and sloped rear drainage systems. A second kennel unit can be stacked to allow up to two kennel units per base.

Parvo Kennel features:

- Disinfectant safe polyethylene kennel shell.
- Raised floor system which keep your client elevated thus minimising contact with their waste.
- Lexan door splatter guard and raised bottom retaining lip help to contain explosive diarrhoea.

Isolation Kennels

Product Code Description

925.3931.01	Parvo Kennel
925.2000.02	Upper Parvo Kennel
925.2000.03	Two Unit Parvo Kennel







Isolation Kennel Sizes

L (mm)	W (mm)	H1 (mm)	H2 (mm)
984.25	863.6	1219.2	787.4

YesWeCanSee®

...monitoring care 24/7

Monitor your inpatients from anywhere in the world

	MOVE - Choose the best shot and move the camera to the desired position
	VIEW - View the inside of the kennel
	LISTEN - Listen to the animal to check its health status and speak to stimulate the patient
	ILLUMINATE - Illuminate the area to stimulate the patient or to offer extra lighting
	PICTURE - Take a picture and save it to view later
	VIDEO - Record a video and save it to view later
IR	MANUAL INFRARED - Turn the Infrared vision on or off to get the best view in difficult lighting environments.

YesWeCanSee® is an enhanced webcam monitoring system providing remote, 4-way interaction with inpatients wherever there is internet access.

- **View** - move remote control camera to ideal examination position using pre-set values (ideal when internet connection is poor)
- **Talk/Hear** - speak or listen with inbuilt microphone, enhancing observation options
- **Illuminate** - boost light for improved vision or switch to infra-red for night-time monitoring to minimise animal disturbance (can be controlled manually via the App)
- **Record** - take photographs or video for your patient records

Additionally, should you wish to, you can offer time-controlled access to your clients to see their pet whilst an inpatient, by giving access to YesWeCanSee® from their personal internet connection.



YesWeCanSee™

Product Code	Description
EUR.1111.00	YesWeCanSee® Web Cam

SURGERY TABLES



Continuum Flat Top Hydraulic Base Surgery Table

- Maximum working height of table top 1041mm
- Minimum working height of table top 775mm
- Maximum load weight 113kg
- All stainless steel top with fully rounded corners
- Slight centre elevation with shallow trough around the table top edges
- Near vertical positioning
- Attachment rail on all sides of the table
- Four sliding quick release cam cleat tie down attachments
- Table base is designed so that the surgeon and other surgical equipment can come into close proximity to the table
- Four levelling screws to allow you to adjust the table base

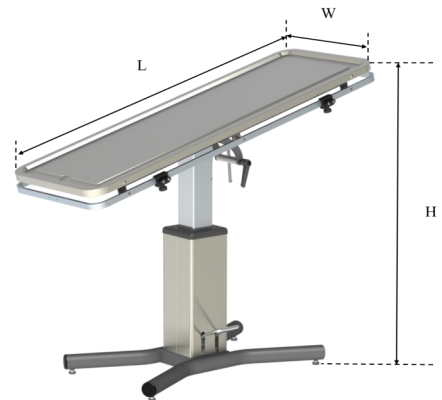
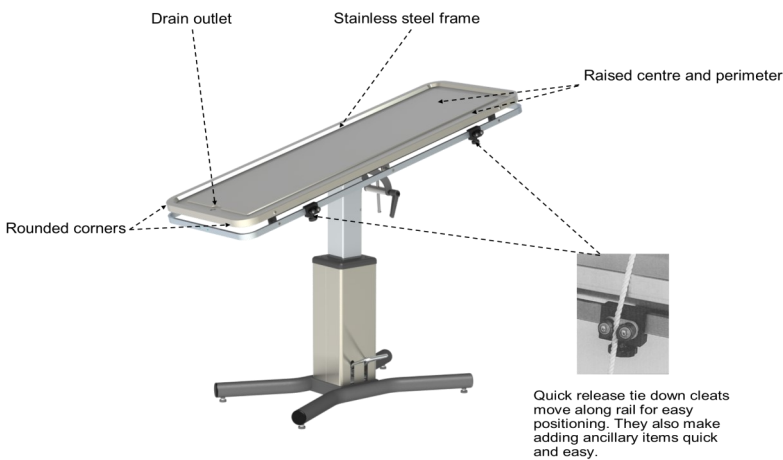

Continuum Flat Top Hydraulic Base Surgery Table

Product Code	Description
903.4000.04	Continuum Flat Top Hydraulic Base Surgery Table

Continuum Flat Top Hydraulic Base Surgery Table Size

W (mm)	H (mm) min	H (mm) max	L (mm)
559	755	1041	1524

SURGERY TABLES



Continuum V-Top Hydraulic Base Surgery Table

- All Stainless Steel top
- Maximum Height 1041mm
- Minimum Height 775mm
- Maximum load weight 113kg
- A 76.2mm wide stainless steel trough collects fluid runoff into a drain outlet
- New design top panels open 270° for easy access to the trough for removal of surgical waste.
- Near vertical positioning
- Attachment rail on either side of the table
- Four sliding quick release cam cleat tie down attachments
- Table base is designed so that the surgeon and other surgical equipment can come into close proximity to the table
- Four levelling screws to allow you to adjust the table base

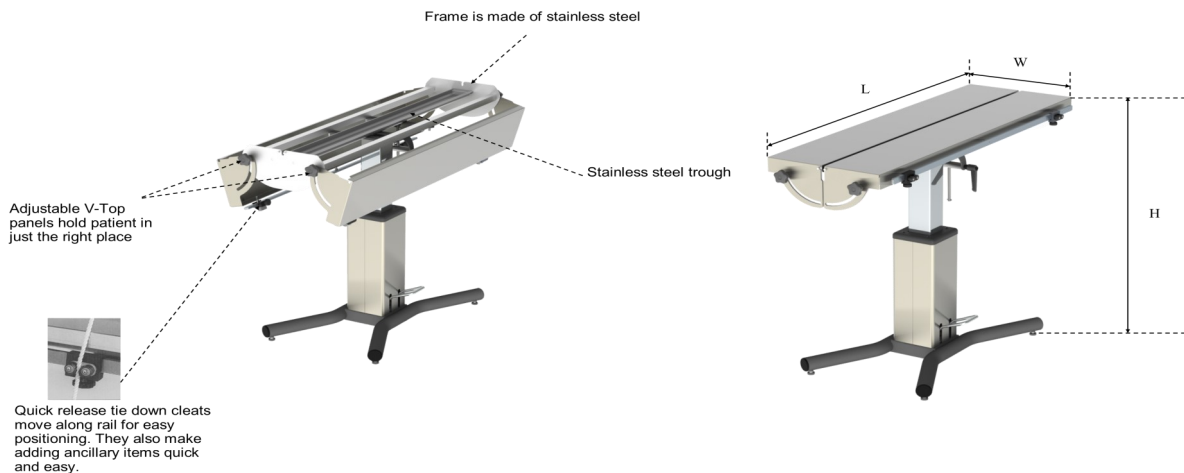

Continuum V-Top Hydraulic Base Surgery Table

Product Code	Description
903.4100.01	Continuum V-Top Hydraulic Base Surgery Table

Continuum V-Top Hydraulic Base Surgery Table Size

W (mm)	H (mm) min	H (mm) max	L (mm)
482.6	775	1041	1473

SURGERY TABLES



Classic Flat Top Surgery Table

- All Stainless Steel
- Maximum Height 996.9 mm
- Minimum Height 730.2 mm
- Maximum load weight 136kg
- Fully rounded corners on table top
- Slight centre elevation with shallow trough around the table top edges
- 360° revolving capability and near vertical positioning
- Attachment rail on all sides of the table
- Four sliding quick release cam cleat tie down attachments
- Available with foot operated Hydraulic Base or Electric Lift Base
- Table Base has the option of offset wheels for ease of movement and excellent positioning

Raised centre and perimeter trough

Frame is made of stainless steel

Drain outlet

Rounded corners



Quick release tie down cleats move along rail for easy positioning. They also make adding ancillary items quick and easy.



Classic Flat Top Surgery Table

Surgery Table is 558.8 mm wide x 1524mm long x between 730.2 & 996.9 mm high

Product Code	Description
903.4000.00	Flat-Top Surgery Table with Hydraulic Lift base
903.4020.01	Flat-Top Surgery Table with Electric Lift base

SURGERY TABLES



Classic V-Top Surgery Table

- All Stainless Steel
- Maximum Height 1041.4mm
- Minimum Height 774.7mm
- Maximum load weight 136kg
- Two V-Top panels adjust independently from either end of the table
- 360° revolving capability and near vertical positioning
- Attachment rail on either side of the table
- Two sliding quick release cam cleat tie down attachments
- 762mm stainless steel trough centred under the two V-Top panels
- Available with foot operated Hydraulic Base or Electric Lift Base
- Table Base has the option of offset wheels for ease of movement and excellent positioning

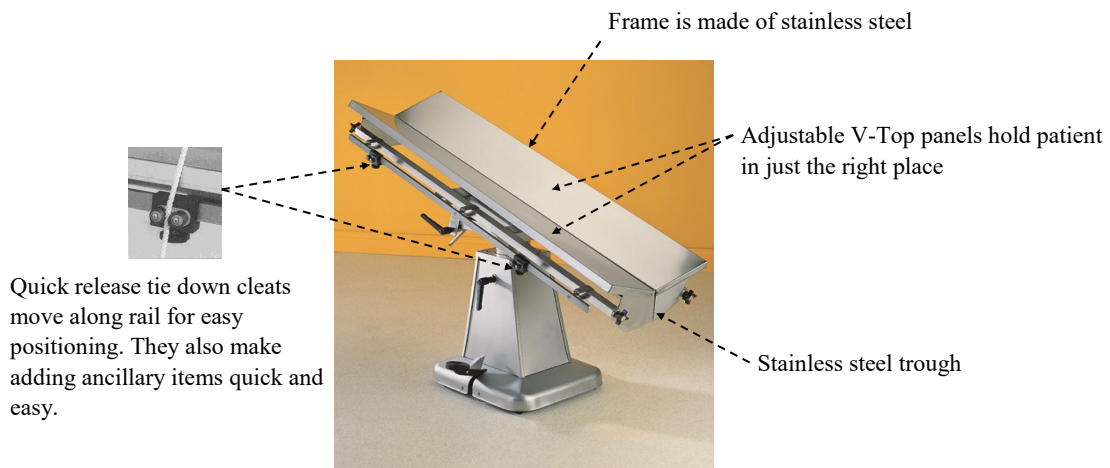

Classic V-Top Surgery Table

Surgery Table is 482.6 mm wide x 1473.2 mm long x between 774.7 & 1041.4 mm high

Product Code	Description
903.4100.00	V -Top Surgery Table with Hydraulic Lift base
903.4120.01	V - Top Surgery Table with Electric Lift base

ELECTRIC LIFT TABLES

Cojack-Plus Multi-Purpose Table

The Cojack-Plus Multi-Purpose Table meets all your patient lifting, exam, transport and surgical procedure needs.

The footswitch operates a dual rechargeable 24 volt actuator system that lifts up to 113kg.

The Cojack-Plus Multi Purpose Table features:

- Stainless steel top with raised edges to prevent fluid run-off.
- Drain opening with hook for a collection pail.
- Two tie down restraint cleats on each side for secure animal transport.
- Adjustable IV holder.
- Four non-marking bumpers.
- Four nylon swivel and locking castors provide easy manoeuvrability.

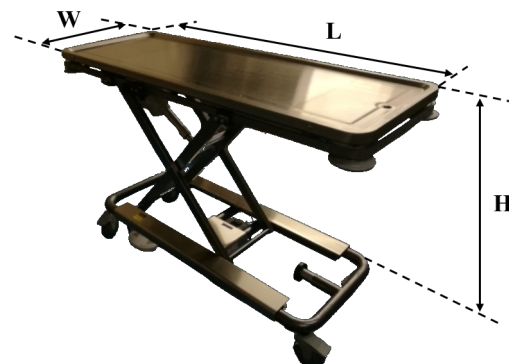

Cojack-Plus Multi Purpose Table

Product Code	Description
903.3130.01	Cojack Plus Multi Purpose Surgery and Procedure Table

Cojack-Plus Multi Purpose Table Sizes

W (mm)	H (mm) min	H (mm) max	L (mm)
558.8	355.6	1016.0	1524.00

Tables



Mobile Animal Lift Table

The Shor-Line Mobile Animal Lift Table is ideal for lifting injured and post operative patients, saving time and effort.

- Maximum Load 90.7kg.
- Stainless Steel Top with raised edges to prevent fluid run-off.
- Bronze load bearings ensure long life and quiet operation.
- Four fixed tie-downs for animal restraint.
- Four non-marking bumpers.
- Full charge in just 240 minutes.
- Four nylon swivel and locking castors provide easy manoeuvrability.

Mobile Animal Lift Table Sizes

Product Code	Description	W (mm)	H (mm) min	H (mm) max	L (mm)
903.3120.00	Mobile Animal Lift Table	508 (Overall 787)	273	950	1130 (overall 1320)



EXAMINATION TABLES

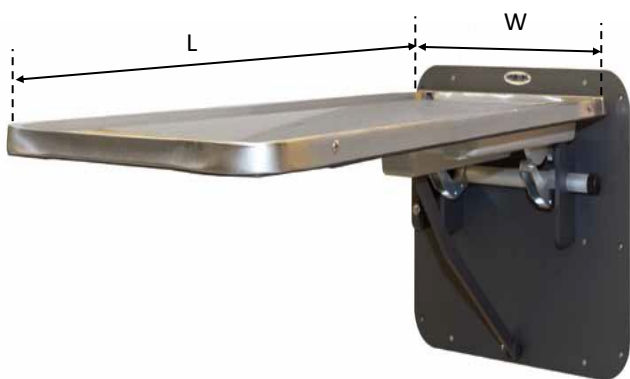

Fold-up Wall-Mount Examination Table

When folded against the wall, the Fold-up Wall-Mount Examination Table only extends 165 mm leaving your room free for other purposes.

- Uses torsion spring technology which allows you to easily and safely raise and lower the table.
- Adjustable counterbalance spring for fine adjustment.
- Adjustable stop allows for exact levelling of the work top.
- Stainless Steel one piece die-formed top has raised edges to prevent fluid run off.
- Fluid retaining shelf collects fluid run off if table is lifted before it is cleaned.
- Rounded corners let you work comfortably from any angle.

Fold-up Wall-Mount Examination Table

Product Code	Description	W (mm)	L (mm)
903.1130.04	Fold-up Wall-Mount Examination Table	558.8	1117.6



Tables

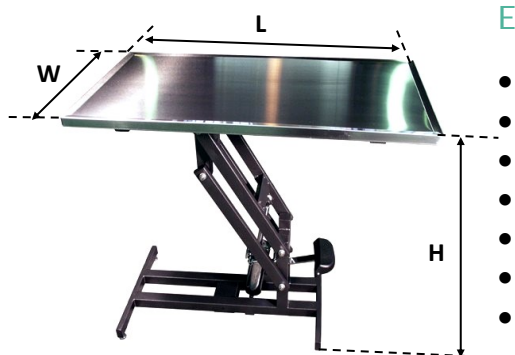

Examination Table with Hydraulic & Electric Base

- Maximum Height 1041 mm
- Minimum Height 508 mm
- Stainless Steel Table Surface with raised edges to prevent fluid run-off
- Dimensions of Table Top 1168 mm x 635 mm
- Maximum Load Weight 90 kg
- Foot pedal locks the table at the desired height
- Electric Motor 240V with full CE approval

Examination Table with Hydraulic & Electric Base Sizes

Product Code	Description	W (mm)	H (mm) min	H (mm) max	L (mm)
903.1240.02	Examination Table with Hydraulic Base	635	508	1041	1168
903.1240.01	Examination Table with Electric Base	635	508	1041	1168

INSTRUMENT TABLES



Mobile Instrument Table

This convenient, versatile table is sized to fit easily over all standard small animal surgery tables. The large work surface provides ample room for your instruments and/or monitoring equipment.

- Handle adjusts the table top height from 1016mm to 1346.2mm which neatly slides under the table when not in use.
- Table work surface measures 1016mm long x 584.2mm wide.
- Four castors are equipped with locking brakes which keep the table in the desired position.

Mobile Instrument Table

Product Code	Description	L1 (mm)	L2 (mm)	W (mm)	H minimum (mm)	H maximum (mm)
903.2003.00	Mobile Instrument Table	1016.0	838.2	584.2	1016.00	1524.0

Tables



Mobile Preparation Table

Built for service and unlimited use, you'll easily accommodate even your larger patients with this over sized table top. An additional shelf is supplied for added versatility.

- Features a 100% heavy gauge stainless steel top with raised edges and is attached to a welded tubular stainless steel frame.
- Four locking castors

Mobile Preparation Table

Product Code	Description	L (mm)	W (mm)	H (mm)
903.1120.04	Mobile Preparation Table	1130.3	508.0	863.6

TUB TABLES



White Laminate Knee Space Tub Table

Dirty procedures in practice require extensive clean-up. All of these procedures become easier, cleaner and more efficient when performed on our Multi-Purpose Tub Table.

- Rounded knee-space which eliminates sharp corners and edges and improves comfort during procedures.
- Recessed 2 piece grill makes removal and clean-up quicker and easier.
- 3 mm PVC wrapped on all doors and drawer edges to prevent chipping and for additional moisture protection.
- Cabinets are constructed of 19 mm Moisture Resistant Board.

White Laminate Knee Space Tub Table Sizes

Product Code	Description	W (mm)	H (mm)	L (mm)
904.4000.10	Knee Space Tub Table with Door & 3 Drawers 152.4mm deep Right Hand Knee Space 1540 mm long	634	922	1540
904.4000.11	Knee Space Tub Table with Door & 3 Drawers 152.4mm deep Left Hand Knee Space 1540 mm long	634	922	1540
904.4100.10	Knee Space Tub Table with Door & 3 Drawers 152.4mm deep Right Hand Knee Space 1166 mm long	634	922	1166
904.4100.11	Knee Space Tub Table with Door & 3 Drawers 152.4mm deep Left Hand Knee Space 1166 mm long	634	922	1166

All Stainless Steel Tub Table

Many procedures in practice require extensive clean-up; dentistry, surgery preparation, minor surgery and grooming to name a few. All of these procedures become easier, cleaner and more efficient when performed on a Shor-Line Multi-Purpose All Stainless Steel Tub/ Table.

- Rounded knee-space which eliminates sharp corners and edges and improves comfort during procedures.
- Recessed 2 piece grill makes removal and clean-up quicker and easier.
- 1 Door and 3 large solid panel drawers that fully extend. (taps not included).



All Stainless Steel Tub Table Sizes

Product Code	Description	W (mm)	H (mm)	L (mm)
904.5000.00	Knee Space Tub Table with Door & 3 Drawers 152.4mm deep Right Hand Knee Space 1540 mm long	634	922	1540
904.5000.01	Knee Space Tub Table with Door & 3 Drawers 152.4mm deep Left Hand Knee Space 1540 mm long	634	922	1540
904.5000.07	Knee Space Tub Table with Door & 3 Drawers 152.4mm deep Right Hand Knee Space 1166 mm long	634	922	1166
904.5000.08	Knee Space Tub Table with Door & 3 Drawers 152.4mm deep Left Hand Knee Space 1166 mm long	634	922	1166

TUB TABLES

Tub Table with Stainless Steel Legs

Many procedures in practice require extensive clean-up; dentistry, surgery preparation, minor surgery and grooming to name a few. All of these procedures become easier, cleaner and more efficient when performed on a Shor-Line Tub Table with Stainless Steel Legs.

- All Stainless Steel Tub and frame so suitable for any area with high humidity and or wet floors.
- Recessed 2 piece grill make removal and clean-up quicker an easier.
- 4 Adjustable feet.
(taps not included).



Tub Table with Stainless Steel Legs Sizes

Product Code	Description	W (mm)	H (mm)	L (mm)
904.3000.00	Tub/Table with Stainless Steel Legs 152.4 mm deep x 1536.7 mm long	627.06	914.4	1536.7
904.3001.00	Tub/Table with Stainless Steel Legs 406.4 mm deep x 1536.7 mm long	627.06	914.4	1536.7
904.3100.00	Tub/Table with Stainless Steel Legs 152.4 mm deep x 1168.4 mm long	627.06	914.4	1536.7
904.3101.00	Tub/Table with Stainless Steel Legs 406.4 mm deep x 1168.4 mm long	627.06	914.4	1536.7

TUB TABLE ACCESSORIES

Stainless Steel Solid Top

Formed from a solid sheet of heavy gauge stainless steel, this removable Solid Top fits neatly over our Tub Table to provide a solid work surface.



Stainless Steel Solid Top

Product Code	Description	L (mm)	W (mm)
804.3004.03	Stainless Steel Solid Top for all Tub Tables 1536.7 mm in length	1204.9	631.8
804.3104.03	Stainless Steel Solid Top for all Tub Tables 1168.4mm in length	849.3	625.5

Economy Deck Mounted Mixing Faucet



Featuring a wide radius gooseneck nozzle with aerator and automatic diverter, water is directed over the centre of the Tub Table where you need it most. Large 101.6mm long faucet handles allow activation with wrist or forearm.

Also included is a pre-rinse sprayer with 1727.2mm flexible stainless steel hose. A 50.8 mm spray nozzle head directs water flow where you need it.

Economy Deck Mounted Mixing Faucet

Product Code	Description
804.0006.51	Economy Deck Mounted Mixing Faucet

BATHING/GROOMING TUB TABLES



Classic Grooming Tub

Featuring sturdy tube frame construction, the Classic Grooming Tub is built to last.

A one-piece backsplash and adjustable feet make it sturdy whether it is free-standing in a room or placed against a wall.

- Constructed with radiused corners along all the corners of the shower
- 45° angles on the front edges add safety and aesthetic appeal
- PVC Coated Tub Floors have the option of a floor panel set upon the rails to raise the grooming platform to an ergonomic grooming level
- Sliding restraint ring design allows dogs to be turned around in the tub without detaching the safety lead
- Supply Caddy can be completely removed and 2 plugs are provided to close the mounting holes
- Includes: Supply Caddy, 2 PVC Coated Tub Floor Panels, Hair Trap Drain Insert and Restraint Ring

Plumbing fixtures not included

Backsplash Grooming Tub Table Sizes

Product Code	Description	W (mm)	H (mm)	L (mm)
904.0702.34	Classic Grooming Tub, Right Hand Drain	620.7	1524.0	1403
904.0400.35	Classic Grooming Tub, Left Hand Drain	620.7	1524.0	1403

Elite Grooming Tub Table

This tub's construction features the same tube frame as our kennels, a one piece-backsplash and adjustable feet, making it sturdy whether it's free-standing in a room or placed against a wall.

- Radiused corners on all corners of the Tub means no 90° edges that clothing can get stuck on.
- Featuring our innovative STAMP (STeprAMP) system that collapses steps into a ramp. The STAMP system provides two functions in one and conveniently folds away under the shower for storage while not in use.
- Slide in and slide out steps/ramp can be operated without bending down. No hands required.
- Slip resistant tread on steps/ramp.
- PVC Coated Tub Floors have the option of a floor panel set upon the rails to raise the showering platform to a more convenient showering level.
- Door is completely removable and features the same hinges that are used on our kennels
- Door latch is easy to use and constructed of the same long lasting material as our hinges.
- Sliding restraint ring design allows dogs to be turned around in the tub without detaching the safety lead.
- Supply Caddy can be completely removed and 2 plugs are provided to close the mounting holes.
- Includes: Supply Caddy, 2 PVC Coated Tub Floor Panels, Hair Trap Drain Insert and Restraint Ring.
- Plumbing fixtures are not included and may be purchased separately.



Step up Grooming Tubs Sizes

Product Code	Description	W (mm)	H (mm)	L (mm)
904.0702.41	Elite Grooming Tub Right Hand Door, Left Hand Drain	609.6	1524.0	1403.0
904.0702.40	Elite Grooming Tub Left Hand Door, Right Hand Drain	609.6	1524.0	1403.0

BATHING/GROOMING TUB

TABLE ACCESSORIES

Wall Mount Faucet

Water is automatically diverted to the light-weight aluminium spray head when handle is used.

Vinyl coil hose easily extends and retracts.



Wall Mount Faucet

Product Code	Description
804.0011.52	Wall Mount Faucet with Aluminium Spray Head and heavy duty vinyl hose

Tables

SURGEONS SCRUB SINK



Surgeons Scrub Sink

Compact wall mounted sink is ideal for use in operating theatres and examination rooms. Manufactured from pristine finished Stainless Steel these sink units feature a fully welded construction with rounded corners to eliminate sharp edges.

All necessary fixing brackets supplied.



Construction Material:	304 Stainless Steel.
Finish:	Pristine finish.
Plumbing requirements:	Pre-mixed water. Outlet 1 1/2" BSP (M)
Min. Water Pressure:	1 bar.

Surgeons Scrub Sink Size

W (mm)	L (mm)	H (mm)	H1 (mm)
550	750	737	250

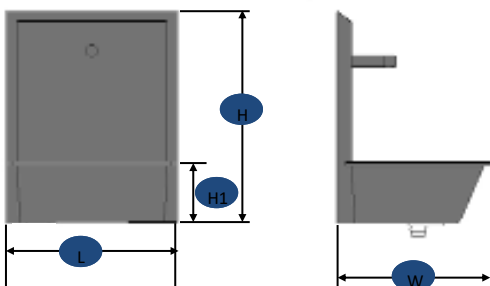

Surgeons Scrub Sink Product Codes

Product Code	Description
904.0200.04	Scrub Sink with Mixer Tap

WEIGHING EQUIPMENT

K9-W8 Scale Features

Shor-Line Canine Scales provide accurate, reliable and repeatable weights in both kilograms and pounds.

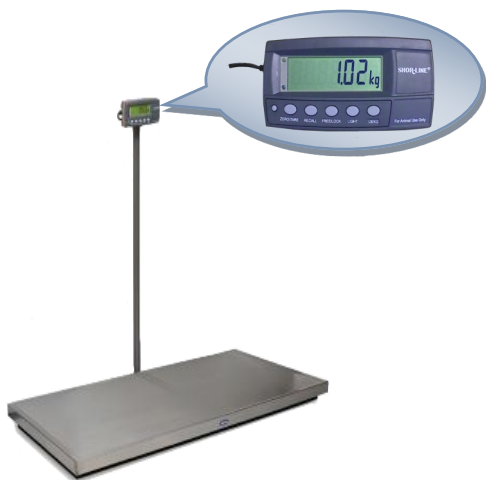

- Display available as Post Mount or Wall Mount
- Stainless Steel Platform
- Four ultra low profile load cells at each corner of the Platform which provides accurate and reliable weights in kilograms and pounds
- A liquid resistant shroud that spans the length of the Platform provides protection from cleaning and also protects the load cells from water ingress
- Large, easy to see backlit LCD screen with 25.4mm high numbers
- 136kg (300lb) capacity
- Tare, Recall, kg/lbs, Light, Free/Lock functions
- Display operates on AC adaptor or 4 AA Batteries
- Grey, ribbed, non-skid mat to provide solid patient footing
- Fluid retaining lip which prevents runoff
- 2m data cable
- Post Mounted Display is 933mm from the floor



K9-W8 Scale Platform Size

W (mm)	L (mm)	H (mm)
571.5	1130.3	63.5

K9-W8 Scale Product Codes

Product Code	Description
905.5010.40	K9-W8 Scale with Post Mounted Readout
905.5010.30	K9-W8 Scale with Remote Mounted Readout

Feline Scale

Compact in size which saves worktop space but large enough to accurately weigh your largest feline patients.

The Feline Scale features:

- Push button zero/tare weight
- Kilogram/pound switch
- 20kg/44lb capacity in 10g/0.02lb increments
- Removable tray for easy cleaning
- 9 Volt battery included



Feline Scale

Product Code	Description
905.0400.05	Feline Scale

PRELUDE SURGERY LIGHTS

The Prelude Surgery Lights offer all the benefits of comfort and energy savings with the supreme quality of Shor-Line.

The 18 highly efficient bulbs produce very low heat which provides a comfortable working environment.

Controlling the brightness and position of your light is essential. With the use of the dimming switch, you will be able to adjust the brightness from 40,000 to 90,000 Lux. The easy to operate and drift free arm system will ensure that the most comfortable position is achieved.

Available as Single Ceiling, Dual Ceiling, Wall and Mobile options.



Optical (measured at 1 metre)	18 White Light LED's with individual parabolic reflectors
Central Illuminance (Ec)	90,000 Lux
Light field Diameter (d10)	242mm
Light field Diameter (d50)	142mm
Adjustable Dimming	40,000 to 90,000 Lux
LED Life	75,000 + Hours
Depth of Illumination	782mm
Light Pattern	152mm
Colour Temperature	4,500 ⁰ K
Colour Rendering Index (Ra)	90

Surgery Light Product Codes

Product Code	Description
913.8000.00	Prelude LED Ceiling Mount Surgery Light, Single Head
913.8000.01	Prelude LED Ceiling Mount Surgery Light, Double Head
913.8000.02	Prelude LED Wall Mount Surgery Light, Single Head
913.8000.03	Prelude LED Mobile Surgery Light

PRELUDE EXAMINATION LIGHTS

The Prelude LED Examination Lights offer all the benefits of comfort and energy savings with the supreme quality of Shor-Line.

The 11 highly efficient bulbs produce very low heat which provides a comfortable working environment.

Controlling the brightness and position of your light is essential. With the use of the dimming switch, you will be able to adjust the brightness from 20,000 to 40,000 Lux. The easy to operate and drift free arm system will ensure that the most comfortable position is achieved.

- 40,000 Lux at 1 metre working distance
- 11 White LED's with individual parabolic reflectors
- Colour temperature of 4,500K which provide visual tissue clarity
- Easily positioned and drift free arm system



Examination Light Product Codes

Product Code	Description
913.7000.03	Prelude LED Ceiling Mount Examination Light, Single Head
913.7000.04	Prelude LED Wall Mount Surgery Light, Single Head
913.7000.05	Prelude LED Mobile Surgery Light

KENNEL ACCESSORIES

(Stainless Steel Platforms)



Custom engineered for precision stacking and maximising rigidity of kennels, the Stainless Steel Stationary and Mobile Platform is designed to provide your kennels with maximum protection from possible dampness and drafts.

Stainless Steel Mobile Platform

- Large reinforced nylon castors and polyurethane wheels that will not mark floors
- Castors rotate 360 degrees for ease of movement
- All castors feature lock mechanisms to keep your kennel assembly stationary
- Allow 216mm height increase when planning your space requirements

Stainless Steel Stationary Platform

- Adjustable feet in each leg easily help level the Platform
- Allow between 203.2 mm and 235mm height increase when planning your space requirements

Standard Mobile Platform Sizes

Platforms are 717.7mm deep and 203.2mm high

Product Code	Description
702.1800.07	Mobile Platform to fit Kennel: Width 457.2 mm
702.2400.07	Mobile Platform to fit Kennel: Width 609.6 mm
702.3000.07	Mobile Platform to fit Kennel: Width 762.0 mm
702.3600.07	Mobile Platform to fit Kennel: Width 914.4 mm
702.4800.07	Mobile Platform to fit Kennel: Width 1219.2 mm
702.6000.07	Mobile Platform to fit Kennel: Width 1524 mm
702.7200.07	Mobile Platform to fit Kennel: Width 1828.8 mm

Standard Stationary Platform Sizes

Platforms are 717.7mm deep and between 203.2mm and 235.0 mm high

Product Code	Description
802.1800.06	Stationary Platform to fit Kennel: Width 457.2 mm
802.2400.06	Stationary Platform to fit Kennel: Width 609.6 mm
802.3000.06	Stationary Platform to fit Kennel: Width 762 mm
802.3600.06	Stationary Platform to fit Kennel: Width 914.4 mm
802.4800.06	Stationary Platform to fit Kennel: Width 1219.2 mm
802.6000.06	Stationary Platform to fit Kennel: Width 1524 mm
802.7200.06	Stationary Platform to fit Kennel: Width 1828.8 mm

KENNEL ACCESSORIES



End and Top Panels

End Panels and Top Panels are the easiest way to give your individual kennel or kennel assemblies an attractive one piece finished look at one or both ends. Made of the same high quality stainless steel used on the kennel itself, they provide a lifetime of attractive and practical service.

They also eliminate any sharp edges that protrude from the kennel therefore reducing the possibility of cutting you or your patients. Cleaning of the kennel is also made easier as the End Panels and Top Panels give the kennel a smooth, flat surface.

End Panels and Top Panels are ordered separately and are easily attached at your premises.

All End Panels and Top Panels are 717.55 mm deep.



Standard End Panels Sizes

End Panels are 717.5mm deep

Product Code	Description
802.0018.51	Kennel End Panel to fit 457.2 mm high Kennel
802.0024.51	Kennel End Panel to fit 609.6 mm high Kennel
802.0030.51	Kennel End Panel to fit 762.0 mm high Kennel
802.0036.51	Kennel End Panel to fit 914.4 mm high Kennel

Standard Top Panel Sizes

Top Panels are 717.5mm deep

Product Code	Description
802.1800.00	Top Panel 457.2 mm wide
802.2400.00	Top Panel 609.6 mm wide
802.3000.00	Top Panel 762 mm wide
802.3600.00	Top Panel 914.4 mm wide
802.4800.00	Top Panel 1219.2 mm wide
802.6000.00	Top Panel 1524 mm wide
802.7200.00	Top Panel 1828.2 mm wide

Quiet Time Door Cover

Shor-Line Quiet-Time Door Covers provide isolation and solitude for clients during treatment or recovery.

The Quiet Time Door Cover features:

- Colour-fast blue nylon construction which is stain and snag resistant.
- 76 mm deep pocket which fits securely over the top of the kennel door.
- Clear vinyl window so client information can be displayed.
- Machine washable.

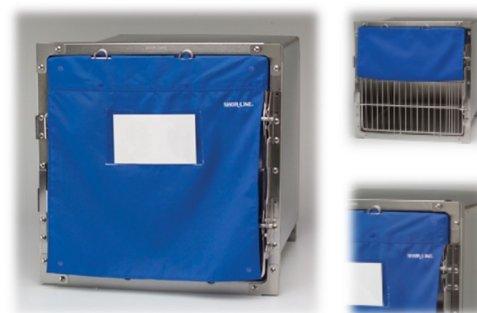

Quiet Time Door Cover

Product Code	Description
179.2424.00	Quiet Time Door Cover for Kennel : Width 609.6 mm x Height 609.6 mm
179.2430.00	Quiet Time Door Cover for Kennel : Width 609.6 mm x Height 762.0 mm
179.3030.00	Quiet Time Door Cover for Kennel : Width 762.0 mm x Height 762.0 mm
179.3630.00	Quiet Time Door Cover for Kennel : Width 914.4 mm x Height 762.0 mm

KENNEL ACCESSORIES

PVC Floors

Made from 14 gauge perforated steel, these PVC Floors allow you to clean your kennel floors without the need to disturb or remove your client. Patients are kept dry and clean as the floor sits 80 mm from the bottom of the kennel.

Non-toxic PVC coating is approximately 3 mm thick and covers the entire floor.

Floors for double door kennels are two piece.

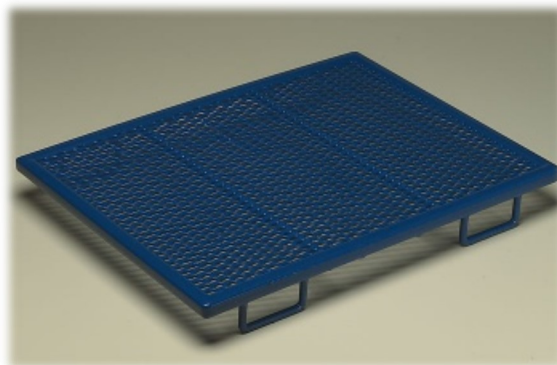

PVC Floors

Product Code	Description
317.0098.00	PVC Floor to fit 457.2 mm wide Kennel
317.0098.01	PVC Floor to fit 609.6 mm wide Kennel
317.0098.02	PVC Floor to fit 762 mm wide Kennel
317.0098.03	PVC Floor to fit 914.4 mm wide Kennel
317.0098.04	PVC Floor to fit 1219.2 mm wide Kennel, single door
317.0098.05	Pair of PVC Floors to fit a Double Door Kennel 1219.2 mm
317.0098.45	Pair of PVC Floors to fit a Double Door Kennel 1524 mm
317.0098.46	Pair of PVC Floors to fit a Double Door Kennel 1828.8 mm
317.0098.99	PVC Floor to fit 457.2 mm wide : x Special 609.6 mm Depth
317.0098.99.7	PVC Floor to fit 609.6 mm wide : x Special 609.6 mm Depth
317.0098.99	PVC Floor to fit 762 mm wide : x Special 609.6 mm Depth
317.0098.99.1	PVC Floor to fit 914.4 mm wide : x Special 609.6 mm Depth

Dividers for use with Double Door Kennels



Our dividers provide a quick and affordable way to convert 1219.2 mm, 1524 mm and 1828.8 mm wide double door Shor-Line kennels into two smaller units.

Made from Thermal Formed ABS, the divider connects to a bracket at the back of the kennel to form a secure separation between each side.

The double door latch system can be quickly and easily removed with one hand when transferring your patient in and out of the kennel.

Dividers for use with Double Door Kennels

Product Code	Description
802.0030.01	Thermal formed Standard Depth Kennel Divider for 762.0 mm High Kennel
802.0036.01	Thermal formed Standard Depth Kennel Divider for 914.4 mm High Kennel

KENNEL ACCESSORIES

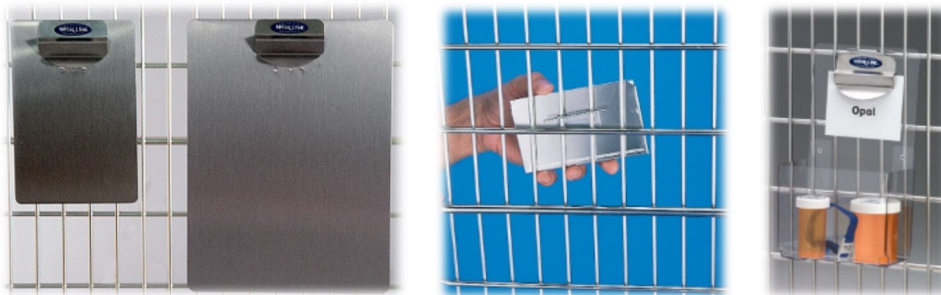

Record/Card & Plastic Medical Holders

Made from durable stainless steel with a chrome plated clip, your client's records will be kept securely attached to your kennel door.

- Twist and turn method attached holders easily to the horizontal bar of the kennel door.
- Clips on the Record Holder and Plastic Medication Holder and three sided pockets on the Card Holders hold your clients details secure.
- Plastic Medical Holder is constructed from polycarbonate material which is crack and shatter resistant.

Record/Card & Plastic Medical Holders

Product Code	Description
802.0010.03	Stainless Steel Record Holder- Width 139.7 mm x Height 190.5 mm
802.0010.04	Stainless Steel Record Holder- Width 228.6 mm x Height 304.8 mm
802.0000.01	Card Holder- Width 127 mm x Height 76.2 mm
802.0000.02	Card Holder- Width 203.2 mm x Height 127 mm
915.0200.04	Medication and Record Holder 140 mm x 266 mm made from clear plastic
915.0200.05	Medication and Record Holder 228.6 mm x 380 mm made from clear plastic



Shor-Shelf© Cat Perching Shelf

The removable Shor-Shelf© allows cats to follow their natural instinct to jump and perch above the floor.

- Shelf is 177.8mm deep and adjusts to fit all 457.2mm, 609.6mm and 762 mm wide kennels.
- Unique flex-ends with special non-slip pads automatically adjusts to taper of kennel therefore no drilling or modification of the kennel is required.

Shor-Shelf© Cat Perching Shelf

Product Code	Description
802.0006.00	CAT Perching Shelf: Adjustable

KENNEL ACCESSORIES



Litter Pans

Designed to provide easy care and clean-up. Made from heavy gauge stainless steel and is also autoclavable.

Litter Pans

Product Code	Description
190.9000.03	CAT Litter Pan - 323.9 mm x 527 mm
190.9000.08	CAT Litter Pan - 323.9 mm x 263.5 mm

Water & Feed Bowls

These heavy-duty bowls are easy to clean, autoclavable and provide the maximum resistance to dents, wear and tear and abuse.

The Stainless Steel Feed and Water Bowls features:

- Polished stainless steel which make it easy to clean.
- Bowls can be nested for storage.
- 945 ml and 1.89L are designed for use with Shor-Line bowl mounting brackets.
- Brackets are constructed of stainless steel and are easy to install.



Water & Feed Bowls

Product Code	Description
890.0200.01	Feline Bowl with Cage Door Mounting Bracket-350 ml (3/8 Quart)
190.9000.09	Stainless Steel Bowl - 473 ml (1 Pint)
190.9000.05	Stainless Steel Bowl-945 ml (1 Quart)
190.9000.06	Stainless Steel Bowl-1.89lt(2 Quart)
802.0002.00	Stainless Steel Bracket for Stainless Steel Bowl-945 ml (1 Quart)
802.0003.01	Stainless Steel Bracket for Stainless Steel Bowl-1.89lt (2 Quart)

Single Oxygen Doors

If you have patients in need of increased oxygen, simply remove your stainless steel kennel door and replace it with an oxygen door.

The 9mm thick plexiglass door is designed for an unobstructed view of the patient.

A soft, closed-cell foam gasket surrounds the door to help retain oxygen levels in the kennel.

Upper and lower adjustable vents allow for a reduction in condensation.

Humification of oxygen is provided by a semi disposable humidifier (3 supplied). Temperature of the aerosoled solutions can be increased or decreased by adding ice or heated water to the attachable chamber.



Single Oxygen Doors

Product Code	Description
914.2424.20	Oxygen Door to fit 609.6mm x 609.6mm Kennel
914.2430.20	Oxygen Door to fit 609.6mm x 762mm Kennel
914.2436.20	Oxygen Door to fit 609.6mm x 914.4mm Kennel
914.3030.20	Oxygen Door to fit 762mm x 762mm Kennel
914.3036.20	Oxygen Door to fit 762mm x 914.4mm Kennel
914.3624.20	Oxygen Door to fit 914.4mm x 609.6mm Kennel
914.3630.20	Oxygen Door to fit 914.4mm x 762mm Kennel
914.3636.20	Oxygen Door to fit 914.4mm x 914.4mm Kennel

KENNEL ACCESSORIES



Oxygen Door Conversion Kits

You can easily convert your double door kennel into an oxygen therapy unit.

The conversion kit comprises of a clear plexiglass door and soft closed-cell foam gasket for the 1219.2mm wide x 762mm or 914.4mm high double door kennel (does not include single Oxygen Door which is sold separately).

Oxygen Door Conversion Kits

Product Code	Description
914.2430.21	Oxygen Door Conversion Kit; use with 914.2430.20
914.2436.21	Oxygen Door Conversion Kit; use with 914.2436.20

Hygrometer/Thermometer

Digital readout which displays temperature and humidity. This comes as standard equipment on all Oxygen Doors but can also be purchased separately.

- Maximum and minimum memory function
- Centigrade or Fahrenheit temperature readout options

Hygrometer/Thermometer

Product Code	Description
025.0005.00	Hygrometer/Thermometer



Humidifier

This Humidifier delivers moist oxygen to alleviate drying of the bronchial passages. This comes as standard equipment on all Oxygen Doors but can also be purchased separately.

- Semi disposable
- Can be cleaned and reused several times

Humidifier

Product Code	Description
025.0004.00	Humidifier for use with Oxygen Doors

P.V.C. Floor for kennels with Oxygen Doors

Made from 14 gauge perforated steel, these PVC Floors allow you to clean your kennel floors without the need to disturb or remove your client. Patients are kept dry and clean as the floor sits 80 mm from the bottom of the kennel.

Non-toxic PVC coating is approximately 3 mm thick and covers the entire floor.

Floors for double door kennel are two piece.

P.V.C. Coated Grill Floor for kennels with Oxygen Doors

Product Code	Description
317.0098.06	P.V.C Floor to fit 609.6mm wide Kennel with O2 Door
317.0098.19	P.V.C Floor to fit 762mm wide Kennel with O2 Door
317.0098.07	P.V.C Floor to fit 914.4mm wide Kennel with O2 Door

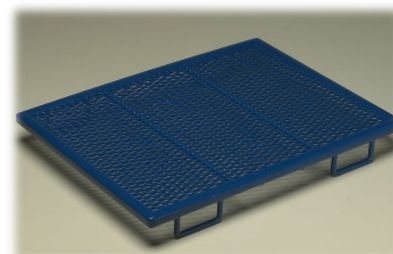

KENNEL ACCESSORIES



Infusion Pump Holder Grill Mount

Mounts easily onto any Shor-Line kennel or Run Gate. It also allows for direct access to the infusion pump displays and controls.

- 220mm length, 25mm height, 10mm depth medical rail

Infusion Pump Holder Grill Mount

Product Code	Description
802.0012.00	Infusion Pump Holder, Grill Mount

Infusion Pump Holder Pole Mount

Mounts easily onto any Shor-Line kennel and provides stable support for your infusion pump. It also allows for direct access to the infusion pump displays and controls.

- Weight of the pump and a twist clasp locks the holder onto the kennel bars
- Adjustable height with dual horn bag hooks

Infusion Pump Holder Pole Mount

Product Code	Description
802.0011.00	Infusion Pump Holder, Pole Mount



Kennel Door I.V. Holder

Keep your floor space clear by attaching your fluids to a kennel door.

- Easily attaches to any Shor-Line kennel door.
- 482.6mm holder adjusts from 50.8mm to 406.4mm above the point of attachment to the door; 889mm holder adjusts from 50.8mm to



Kennel Door

Product Code	Description
802.0001.00	Kennel door I.V. Holder length 482.6mm
802.0001.01	Kennel door I.V. Holder length 889.0mm

SURGERY TABLE ACCESSORIES

Wheels for Surgery Table

Featuring two castors, the Wheels for Surgery Table can be easily fitted to your existing Shor-Line Surgery Table.

- Surgery Table can be moved by lifting the opposite side to the wheels and pushing the table top.
- Stability is not an issue as the Surgery Table remains on its levelling legs until the table is lifted.



Wheels for Surgery Table

Product Code	Description
803.0002.02	Wheels for Surgery Tables

Height Extension

This Height Extension is designed to raise the working surface of your Flat Top or V-Top Surgery Table by 152.4mm.

- Made from 100% Stainless Steel
- Supplied with all necessary fixings

Height Extension

Product Code	Description
803.4000.07	Surgery Table Height Extension



Anti-Fatigue Mats

The Anti-Fatigue Mat is an ideal aid for minimising leg and back discomfort from standing during long procedures or surgeries.

- Features a dual-density closed cell foam.
- Help to distribute weight without making you feel "unstable".
- The mat is 12mm thick with tapered and rolled edges which and can easily be cleaned with soap and water.



Anti-Fatigue Mats

Product Code	Description
803.0100.05	Anti Fatigue Mat 48" x 24" (Pad dimensions 1219 mm x 609 mm)
803.0100.06	Anti Fatigue Mat 48" x 36" (Pad dimensions 1219 mm x 914 mm)
803.0100.07	Anti Fatigue Mat 36" x 24" (Pad dimensions 914 mm x 609 mm)

SURGERY TABLE ACCESSORIES

Dental Extension

The Dental Extension allows standard Flat-Top and V-Top tables to become a wet table for procedures such as dentals and also provides extra space when you need a surgery table to be longer.



- All parts are heavy-gauge Stainless Steel.
- Fits both Shor-Line Flat-Top and V-Top Classic and Continuum Surgery Tables made in the last 20 years.



Height Extension

Product Code	Description
803.4001.08	Flat-Top Table Dental Extension
803.4100.08	V-Top Table Dental Extension



Table IV Holder

The Table IV Holder features a 1219.2mm long IV pole.

- Fits both V-Top and Flat Top Surgery Tables.
- Locks into any position along the attachment rail.
- Kit includes dual hook IV pole and sliding block

Table IV Holder

Product Code	Description
803.0006.10	Table I.V. Holder



Collecting Pail

This large 11.8L capacity Collecting Pail features a free swinging handle for use with all surgery tables designed to hold collecting pails.

Made from 100% seamless, non-corrosive stainless steel.

Collecting Pail

Product Code	Description
190.9000.04	Collecting Pail

TUB TABLES ACCESSORIES



Deck Mounted Economy Faucet

Featuring a wide radius gooseneck nozzle with aerator and automatic diverter, water is directed over the centre of the Tub Table where you need it most. Large 101.6mm long faucet handles allow activation with wrist or forearm.

Also included is an aluminium pre-rinse sprayer with 1727.2mm flexible vinyl hose. A 50.8 mm spray nozzle head directs water flow where you need it.

Deck Mounted Economy Faucet

Product Code	Description
804.0006.50	Deck Mount Economy Faucet, Vinyl Hose and Aluminium Spray Head

Deck Mounted Mixing Faucet

This Deck Mount Mixing Faucet has a 304.8mm swing away nozzle and self closing spray head. The 2438.4 mm long stainless steel hose will extend the length of the Tub Table and allow rinsing of hard to get areas.



Deck Mounted Mixing Faucet

Product Code	Description
804.0006.10	Deck Mounted Mixing Faucet

Lavatory Faucet with Hose and Spray

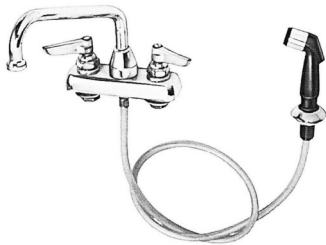

The Lavatory Faucet with Hose and Spray features a 203.2mm swing spout and 1219.2mm vinyl hose with automatic spray diverter. Water is automatically diverted to the spray when handle is used.

Lavatory Faucet with Hose and Spray

Product Code	Description
804.0006.03	Lavatory Faucet with Hose and Spray

Pre Rinse Unit

The Pre Rinse Unit features:

- Polyurethane hose with Stainless Steel outer sleeve
- Brass interior to spray valve
- Stainless Steel compressed safety return spring
- 304.8mm adjustable wall bracket
- Robust and stylish design with maximum flexibility



Pre Rinse Unit

Product Code	Description
SAGE.SPR.8-8	Pre Rinse Unit

DISINFECTANT

Quinticare Plus Disinfectant Detergent

Quinticare Plus is the disinfectant choice of professionals including Veterinary Surgeons and Veterinary Hospitals.

- Quinticare Plus does NOT contain harmful Phenols, Aldehydes or Alcohol.
- Quinticare Plus is NON-toxic, NON-corrosive, NON-staining, NON-tainting and a NON-irritant at all working dilutions.
- Quinticare Plus working dilutions has neutral pH of approximately 7.6.
- There is no need to wash away with water after application and can be immediately brought into direct contact with humans and animals whilst still wet saving you valuable time which can be better spent caring.
- Quinticare Plus is kind to the environment being water based and biodegradable.

Effective Against

Harmful viruses, bacteria and fungi including Canine Parvovirus, Feline Immundeficiency Virus, Feline Leukaemia Virus, Tuberculosis, Avia Flu, MRSA, E.coli...

Quinticare Plus Product Codes

Product Code	Description
806.0002.09	Quinticare Plus: 5 Litre



CUSTOM DESIGN

Custom Design



Picture courtesy of Willows Veterinary Centre and Referral Service, UK.

We at Shor-Line have been designing and manufacturing kennels for over 50 years.

In this time, we have continuously striven to improve our design and materials to suit the needs of the veterinarian and the patient.

Detailed attention should not only be paid to the quality, design and reputation of the kennel you install...equal attention should be paid to the design of your kennel ward, the design of your kennel assembly and its installation.

To ensure that you achieve the best outcome, contact us at the planning stage of your project, be it a branch surgery, a referral centre or a University Veterinary Hospital.

CONTACT US FOR YOUR
FREE CONSULTATION!



Terms and Conditions

PAYMENT TERMS - VETERINARY CUSTOMERS:

1. All prices are quoted for Shor-Line product ex-works Cowbridge, exclusive of VAT.
2. Payment of account is due (14) days from the date of invoice.
3. Late payment of account will attract a surcharge, equivalent to 2% per month from the date that the invoice is due, (e.g., 14 days from the date of invoice).
4. All products remain the property of Shor-Line Ltd until paid for in full.

PRODUCT WARRANTIES:

All Shor-Line stainless steel products are warranted against manufacturer defects in materials and/or workmanship, whilst they are the property of the original purchaser - assuming proper care and maintenance has been carried out.

All mechanical parts and/or electrical devices carry a one year warranty, unless specifically extended or limited in the product description, product inserts or operation manuals.

Some United States warranties, as stated in the operation manuals do not apply outside the United States. These are superseded by European warranties - please check for details.

GUARANTEE OF SATISFACTION:

If a customer is not fully satisfied with the quality of workmanship of a Shor-Line product, Shor-Line must be notified in writing within (10) days of receipt of goods.

Notification should be mailed to: Customer Services Department
Shor-Line Limited
Unit 36
Vale Business Park
Llandow
Cowbridge
Vale of Glamorgan
CF71 7PF
United Kingdom

Telephone: +44 (0) 1446 77 20 41

Facsimile: +44 (0) 1446 77 36 68

Website: www.shor-line.co.uk

E-mail: info@shor-line.co.uk

Proof and date of purchase will be required for your request to be carried out quickly and efficiently.

CUSTOMERS' RECEIPT OF GOODS

Customers are advised to check that the number of packages corresponds with the quantity stated on the "Carrier's Note".

Any discrepancy should be recorded on the note.

Any damages or shortages must be advised to "Shor-Line Limited" within (2) days, and confirmed in writing within (7) days.

No other claim will be considered.

Please note that the claim procedures that are stated on the exterior of the packing material only apply to the United States market.

PRODUCT RETURN AUTHORISATION:

Customers who need to return products must first obtain authorisation from "Shor-Line Customer Services" on 01446 772041.

Products may be returned for the following reasons:

1. *The product is received in a damaged or sub-standard condition.*
2. *The product requires "service" or "repair"*

To assist in the return authorisation please provide the following information:

- a. *The name of the product to be returned and the product code number.*
- b. *The product serial number*
- c. *The reason for return*
- d. *The date of purchase and the Shor-Line Invoice Number*

Shor-Line's Customer Service Department will allocate an Authorisation Number, which will ensure that the repair, replacement and/or credit will be handled quickly and efficiently. Returns will be subject to a 10% re-stock fee.

Kennels

Stainless Steel Kennels 4-5

Kennel Run Gates.....6-8

T-Kennel.....9-11

Stainless Steel Double Cat Suites 12

Cat Condo 13

Plastic Kennels 14

Isolation Kennels..... 14

Monitoring

YesWeCanSee Monitoring Camera.....15

Tables

Continuum Flat Top Surgery Table Hydraulic 16

Continuum V-Top Surgery Table Hydraulic 17

Classic Flat Top Surgery Table..... 18

Classic V-Top Surgery Table..... 19

Electric Lift Tables 20

Examination Tables..... 21

Instrument Tables..... 22

Tub Tables.....23-24

Bathing/Grooming Tub Tables 25

Bathing/Grooming Tub Table Accessories 26

Surgeons Scrub Sink..... 26

Scales

K9-W8 Scale 27

Feline Scale..... 27

Lighting

Prelude Surgery Lights..... 28

Prelude Examination Lights 29

Accessories

Kennel Accessories 30-36

Surgery Table Accessories 37-38

Tub Table Accessories..... 39

Disinfectant

Quinticare Plus Disinfectant 40

Service

Custom Design..... 41

Terms and Conditions 42



SHOR-LINE[®]

SINCE 1927

Vale Business Park
Cowbridge
CF71 7PF
UK

Tel: +44 1446 772041
Fax: +44 1446 773668
Email: info@shor-line.co.uk
Web: www.shor-line.co.uk



<https://www.facebook.com/ShorLineLtd>



<https://twitter.com/ShorlineLtd>